

## 12070

## [mm]

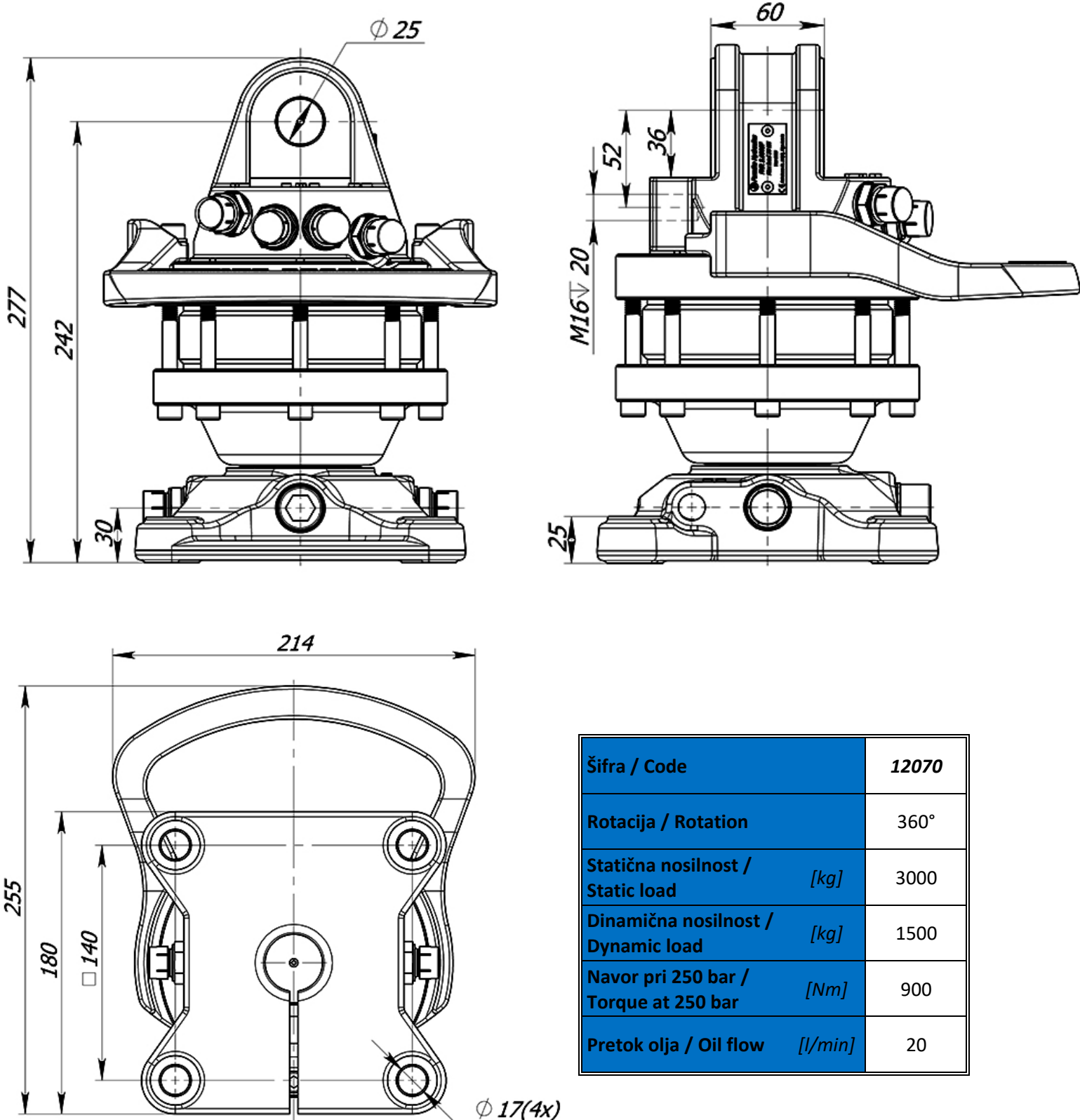

Šifra / Code	12070
Rotacija / Rotation	360°
Statična nosilnost / Static load	[kg] 3000
Dinamična nosilnost / Dynamic load	[kg] 1500
Navor pri 250 bar / Torque at 250 bar	[Nm] 900
Pretok olja / Oil flow	[l/min] 20